

## Materials, per kite

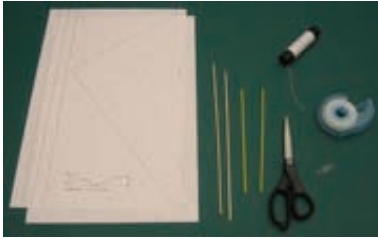

- two pieces of 11x17-inch 20 or 24-lb. bond paper
- two 12-inch bamboo skewers (grocery or garden variety)
- two 7-3/4-inch drinking straws (straight, not flexible), 1/4-inch diameter
- one regular-size (#1) paper clip
- scissors
- Scotch tape (clear instead of "Magic" recommended)
- kite line & winder

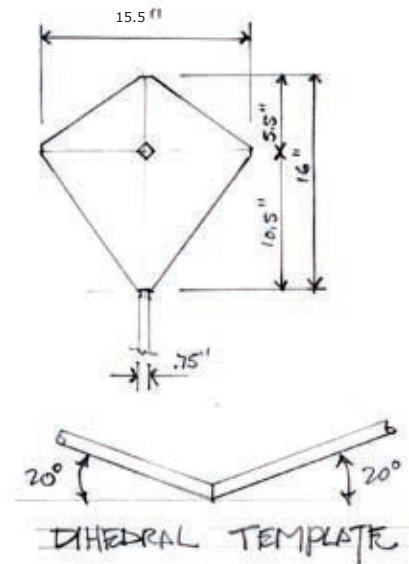

1 Tape together the two pieces of bond paper along the 17-inch edges (overlapping short pieces of tape, if you wish) to create a 17x22-inch rectangle. **Hint:** to keep the papers' edges from shifting during taping,

first lightly tape one piece of paper, at the top and bottom of the 17-inch length, to the work surface. When you have finished taping the two pieces of paper together, fold over or trim any tape extending beyond the top and bottom of the sail.



2 Fold along the vertical taped seam. Cut out six (3 x 2) 3/4-inch strips for the tail first, working in from the unfolded edges. Then draw the sail pattern, per measurements above. Cut out a small central vent and the kite sail. Decorate the kite sail and tail strips on one side, if you like. Re-create the vertical fold in the opposite direction, so that the angle of the fold looks like "V" instead of "Λ" when you place it, undecorated side up, on the work surface.



Decorate the kite sail and tail strips on one side, if you like. Re-create the vertical fold in the opposite direction, so that the angle of the fold looks like "V" instead of "Λ" when you place it, undecorated side up, on the work surface.



3 Put fingers and thumbs together at the center of the paper clip, and bend it to approximately 140 degrees, as pictured. Young

children may need adult assistance, and should be careful of the unrounded ends of the clip. You may not be able to bend the clip's interior loop, and its prongs, to the same angle—don't worry. Measure the angle of the clip against the drawing of the dihedral, above.

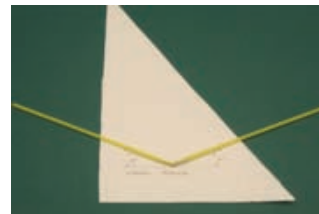

4 Slide the end of one straw over the wider side of the folded clip (the one that ends with the prongs), down to the bottom of the angle. The straw should fit snugly; the interior loop

of the paper clip may help to hold it in place. Align the straw according to the measurements above on the kite sail, with the clip positioned in the middle of the vent. Tape the straw in 2 or 3 places, with short pieces of tape at a right angle to the straw. Fold the triangular end of the sail over the straw spar at the outside edge of the sail, and tape in place.

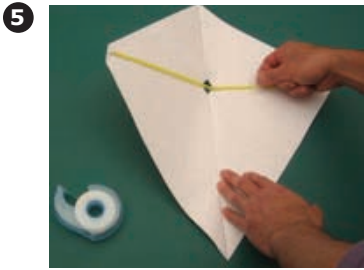

5 Slide the end of the second straw over the narrower side of the folded clip, again down to the bottom of the angle. The second straw will stick up at the angle you created when you folded the clip. The straw may fit more loosely, but should stay in place once you have taped it to the sail. Being careful not to flatten the angle of the paper clip, roll the left half of the sail gently up, so that the untaped spar comes to rest against

the right half of the sail and the work surface. Tape down the second spar, as above. Fold the triangular end of the sail over the straw and tape in place.

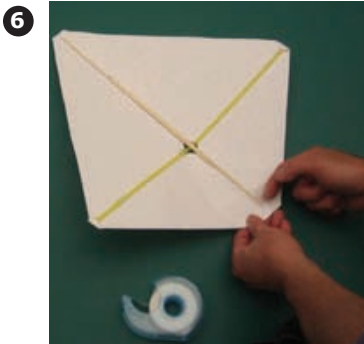
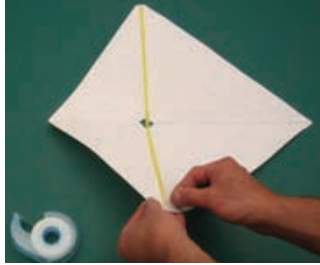

6 Align the bamboo skewers along the vertical taped seam, with the blunt ends of the skewers approximately 1/4-inch in from the top and bottom of the seam. The skewers will overlap in the middle of the kite sail. Tape every 3 to 4 inches over both skewers, with short pieces of tape at a right angle to the skewers. At top and bottom, fold the edge of the sail over the skewers and tape in place.

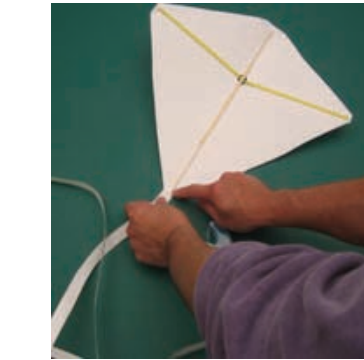

Create two lengths of tail by taping three strips of tail end to end. Lay one length of tail on top of the other, or side by side, and tape both lengths to the bottom of the kite.



7 Tie kite line with two secure overhand (shoelace) knots at the small central vent where the spars intersect. Make sure that the line is tied from the front of the kite sail (the decorated side). The clip should keep the straws at the fixed angle (measure against drawing).

**Note:** Longer straws can be trimmed to the 7-3/4-inch length. Straws of wider diameter may require a bigger paper clip to maintain the fixed angle—and a bigger clip is heavier and may affect your kite's flight. Do not use this kite kit with children younger than age 3.

